

**V-INFINITY**  
a division of CUI INC

date 09/2010

page 1 of 7

**SERIES: 20 W DESKTOP****DESCRIPTION: SWITCHING POWER SUPPLY****FEATURES**

- universal AC input
- regulated output voltage
- short circuit, over load protection
- LED indicator for power on
- meets EISA / efficiency level IV regulations
- custom designs available



MODEL	output voltage		output current		output wattage	ripple	efficiency level	cord length (mm)
	nominal (V dc)		min (A)	max (A)	max (W)	max. (mVp-p)		
ETS050400U	5		0	4	20	150	IV	1000 +150/-0
ETS060330U	6		0	3.3	19.8	150	IV	1000 +150/-0
ETS090220U	9		0	2.2	19.8	150	V	1830 +150/-0
ETS120200U	12		0	2	24	150	V	1830 +150/-0
ETS150133U	15		0	1.33	20	150	V	1830 +150/-0
ETS180110U	18		0	1.1	19.8	150	V	1830 +150/-0
ETS240100U	24		0	1	24	150	V	1830 +150/-0

\*full load, 100~240 Vac input, measured at 20MHz bandwidth with a 10 uF electrolytic cap and a 0.1 uF ceramic cap on the output

**PART NUMBER KEY****ETS050400U T C - XX - SZ - CXX**Base Number  
example of 5 V dc, 4.0 AAC Input Plug:  
blank = IEC 320 C14 plug  
T = IEC 320 C6 plugInput Cable:  
C = included  
blank = no cableDC Plug type:  
see output plug options  
on page 5Factory  
DesignationReserved for  
custom orders



SERIES: 20 W DESKTOP

DESCRIPTION: SWITCHING POWER SUPPLY

**INPUT**

parameter	conditions/description	min	nom	max	units
rated input voltage		100		240	V ac
input voltage range		90		255	V ac
rated frequency		50		60	Hz
frequency range		47		63	Hz
rated input current				0.8	A
inrush current	115 V ac, full load, cold start, 25°C 230 V ac, full load, cold start, 25°C			30 50	A A
no load power consumption	110 ~ 240 V ac			0.5	W

**OUTPUT**

parameter	conditions/description	min	nom	max	units
line regulation			±1		%
load regulation			±5		%
over voltage protection	output shut down	110%		140%	V dc
short circuit protection	output shut down and auto-restart				

**SAFETY & EMI**

parameter	conditions/description	min	nom	max	units
HI-POT	input to output at 10 mA for 1 second			1500 2121	V ac V dc
insulation resistance	input to output at 500 V dc	100			MΩ
safety approvals	UL/cUL, CB (IEC60950-1), CE (GS/TUV EN60950-1)				
EMI standard	FCC part 15 class B, CE (EN55022, EN55024)				
leakage current				3.5	mA
RoHS compliant	yes				

**ENVIRONMENTAL**

parameter	conditions/description	min	nom	max	units
operating temperature		0		40	°C
operating humidity		20		80	%
storage temperature		-10		70	°C
storage humidity		10		90	%



SERIES: 20 W DESKTOP

DESCRIPTION: SWITCHING POWER SUPPLY

**MECHANICAL DRAWING**

case size 99 L x 51 W x 31.7 H mm  
tolerance:  $\pm 1$  mm

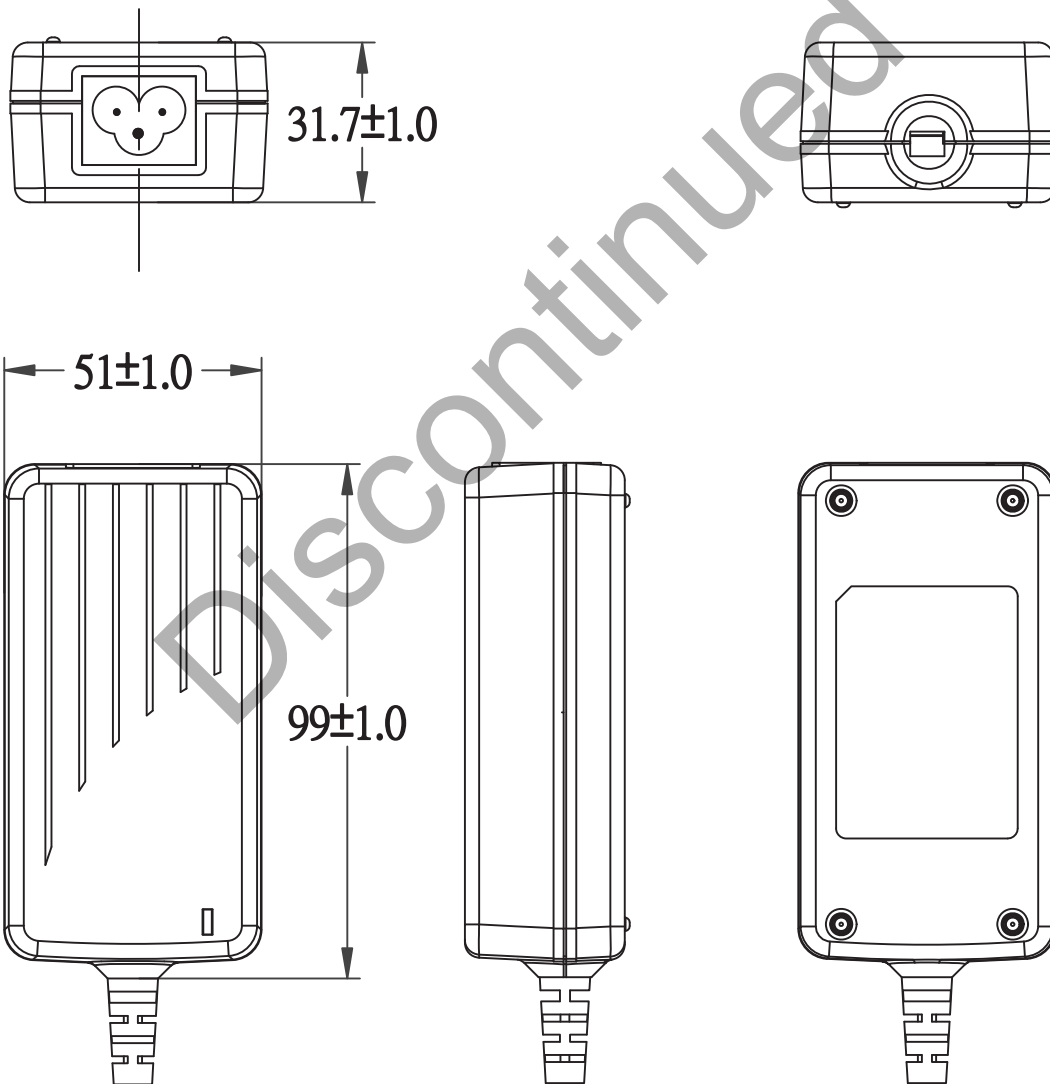



SERIES: 20 W DESKTOP

DESCRIPTION: SWITCHING POWER SUPPLY

DC CORD

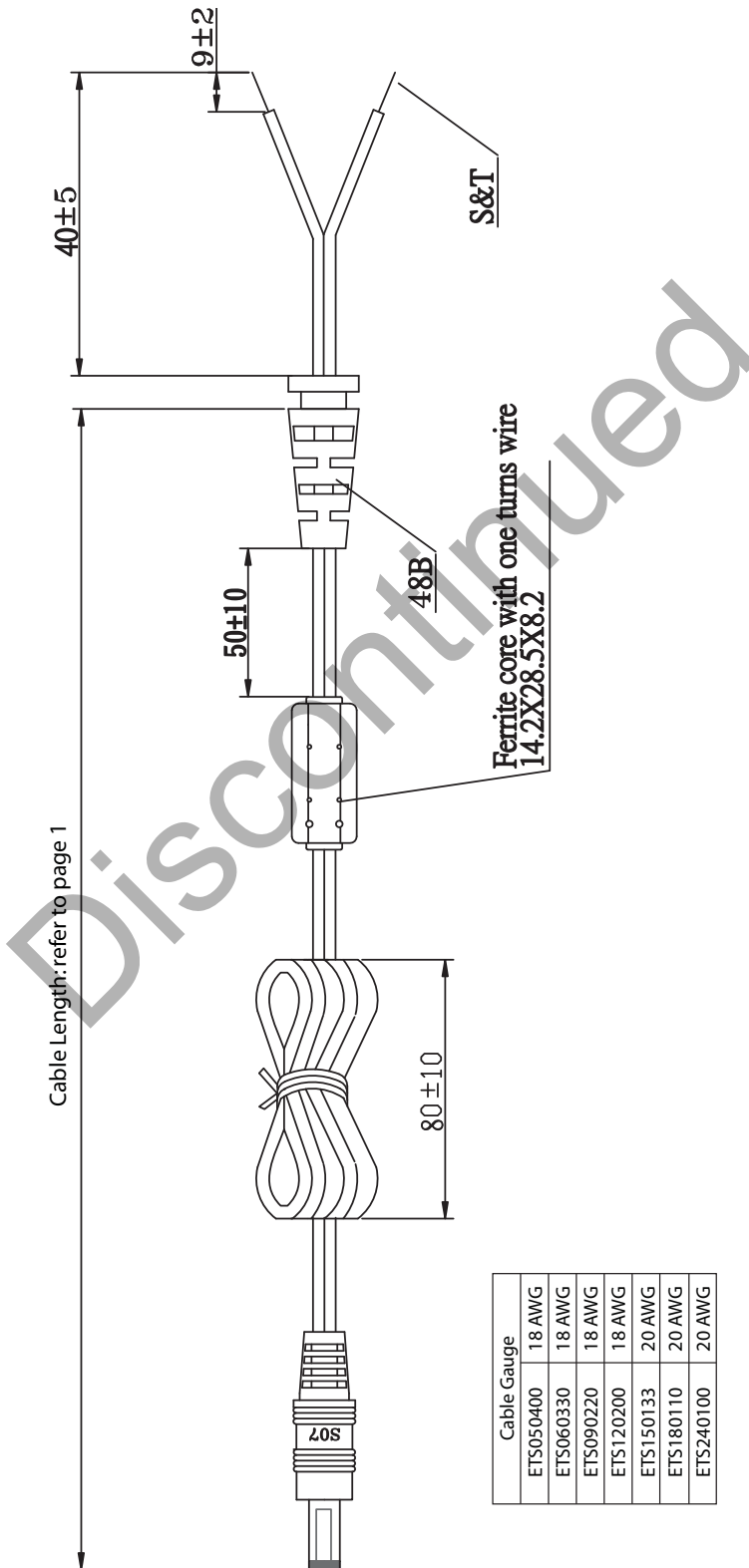



SERIES: 20 W DESKTOP

DESCRIPTION: SWITCHING POWER SUPPLY

**OUTPUT PLUG OPTIONS**

**3.5 mm Phono Plug**

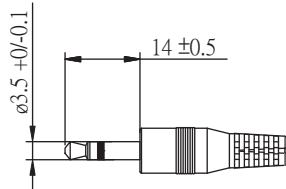

P1

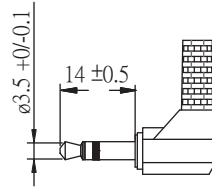

P1R

\*Tip positive

**Standard DC Plug**

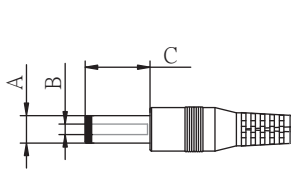

Standard PX

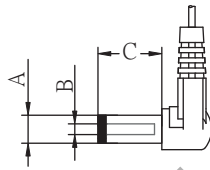

Right Angle PXR

	A	B	C	Unit
P5/P5R	5.5	2.1	9.5	mm
P6/P6R	5.5	2.5	9.5	mm
P7/P7R	3.5	1.3	9.5	mm
P8/P8R	3.8	1.35	9.5	mm
P9/P9R	3.8	1.05	9.5	mm

**Locking DC Plug**

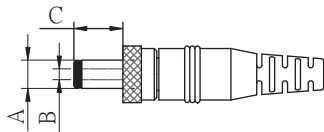

	A	B	C	Unit
P10	5.5	2.1	9.5	mm
P11	5.5	2.5	9.5	mm

**EIAJ Plugs**

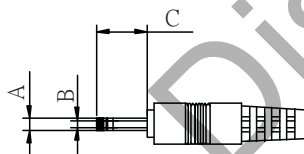

Standard PXX

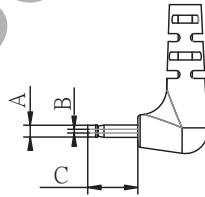

Right Angle PXXR

	EIAJ	A	B	C	D	Unit
P12/P12R	EIAJ-1	2.35	0.7	9.5	NA	mm
P13/P13R	EIAJ-2	4.0	1.7	9.5	5.0	mm
P14/P14R	EIAJ-3	4.75	1.7	9.5	5.0	mm

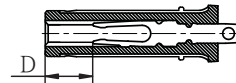

**Stripped and Tinned**

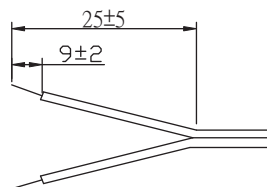

**DC PLUG TYPE**

**ST**  
stripped and tinned

**PXX X X**

Plug type      Plug angle: "blank" = standard  
R = right angle      Plug polarity: "blank" = N/A  
P = center positive      N = center negative

⊖ ⊕ ⊕      ⊕ ⊖ ⊖

\*Contact CUI for additional output plug options.



**V-INFINITY**  
a division of CUI INC

date 09/2010  
page 6 of 7

SERIES: 20 W DESKTOP

DESCRIPTION: SWITCHING POWER SUPPLY

AC CORD

C6

C14

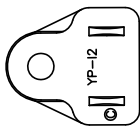
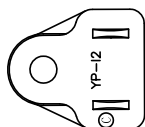
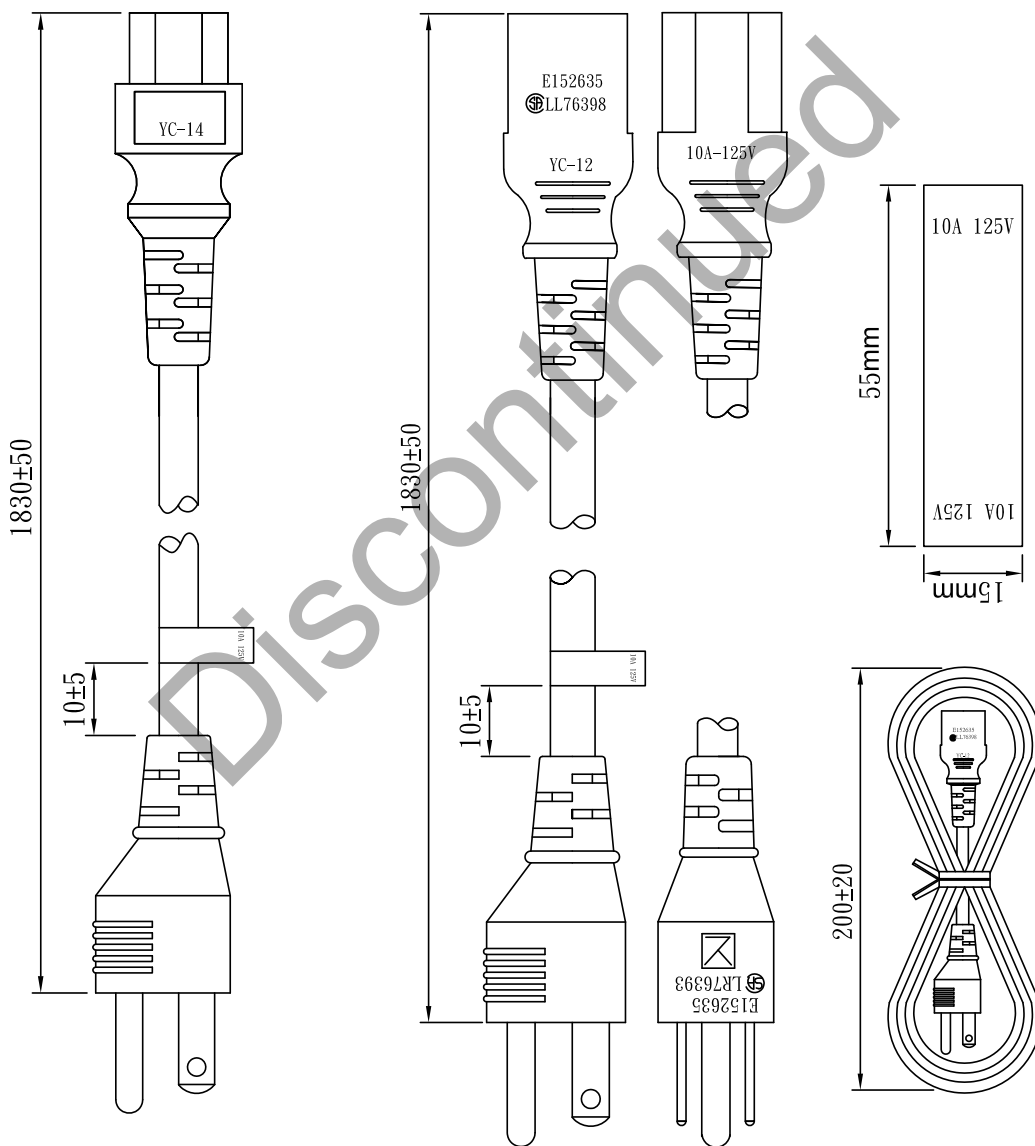
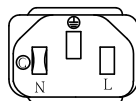
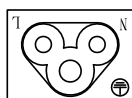

\*Contact CUI for additional ac cord input blade options.



**V-INFINITY**  
a division of CUI INC

date 09/2010

page 7 of 7

SERIES: 20 W DESKTOP

DESCRIPTION: SWITCHING POWER SUPPLY

**INDIVIDUAL PACKAGING**

tolerance  $\pm 1$  mm

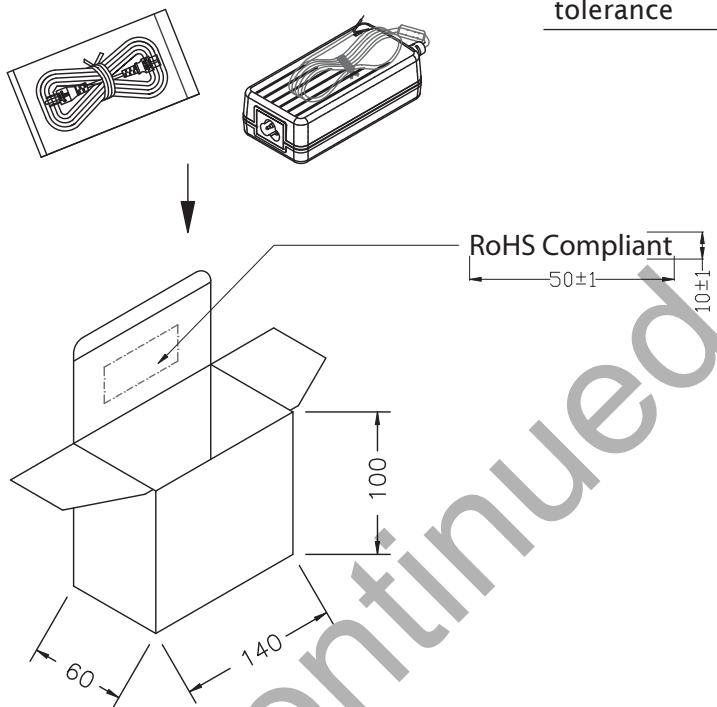

**PACKAGING**

tolerance  $+7 / -0$  mm

CARTON SIZE: 445X327X235

Q'TY: 30pcs(15X2)

