

**V-INFINITY**
a division of CUI INC

date 03/2010

page 1 of 8

SERIES: 60 W DESKTOP**DESCRIPTION: SWITCHING POWER SUPPLY****FEATURES**

- universal AC input
- regulated output voltage
- short circuit, over load protection
- meets EISA / efficiency level IV regulations
- custom designs available



MODEL	output voltage		output current		output wattage	ripple	efficiency level	cord length (mm)
	nominal (V dc)		min (A)	max (A)	max (W)	max. (mVp-p)		
ETS120500U	12		0	5	60	240	IV	1830 +150/-0
ETS150400U	15		0	4	60	240	IV	1830 +150/-0
ETS190315U	19		0	3.15	60	240	V	1830 +150/-0
ETS240250U	24		0	2.5	60	240	V	1830 +150/-0

*at full load, 100 ~ 240 V ac input, measured at 20MHz bandwidth with a 10 uF electrolytic cap and a 0.1 uF ceramic cap on the output

PART NUMBER KEY**ETS120500U T C - PXXXX - SZ - CXX**Base Number
example of 12 V dc, 5 AAC Input Plug:
blank = IEC 320 C14 plug
T = IEC 320 C6 plugInput Cable:
C = included
blank = no cableDC Plug type:
see output plug options
on page 5Factory
DesignationReserved for custom
configurations

**V-INFINITY**
a division of CUI INC

date 03/2010

page 2 of 8

SERIES: 60 W DESKTOP**DESCRIPTION: SWITCHING POWER SUPPLY**

INPUT

parameter	conditions/description	min	nom	max	units
rated input voltage		100		240	V ac
input voltage range		90		264	V ac
rated frequency		50		60	Hz
frequency range		47		63	Hz
rated input current				1.5	A
inrush current	115 V ac, full load, cold start, 25°C 230 V ac, full load, cold start, 25°C			50 100	A A
no load power consumption	100 ~ 240 V ac input			0.5	W

OUTPUT

parameter	conditions/description	min	nom	max	units
line regulation			±1		%
load regulation			±5		%
over voltage protection	output shut down	140%		160%	V dc
short circuit protection	output shut down and auto-restart				

SAFETY & EMI

parameter	conditions/description	min	nom	max	units
HI-POT	input to output at 10 mA for 1 second			1500	V ac
insulation resistance	input to output at 500 V dc	100			MΩ
safety approvals	UL/cUL, CB (IEC60950-1), CE (GS/TUV EN60950-1), RCM				
EMI standard	FCC part 15 class B, CE (EN55022, EN55024)				
leakage current				3.5	mA
RoHS compliant	yes				
LPS power supply	yes				

ENVIRONMENTAL

parameter	conditions/description	min	nom	max	units
operating temperature		0		40	°C
operating humidity		20		80	%
storage temperature		-10		70	°C
storage humidity		10		90	%



SERIES: 60 W DESKTOP

DESCRIPTION: SWITCHING POWER SUPPLY

MECHANICAL DRAWING

case size 116 L x 50 W x 31 H mm
tolerance: ± 1 mm

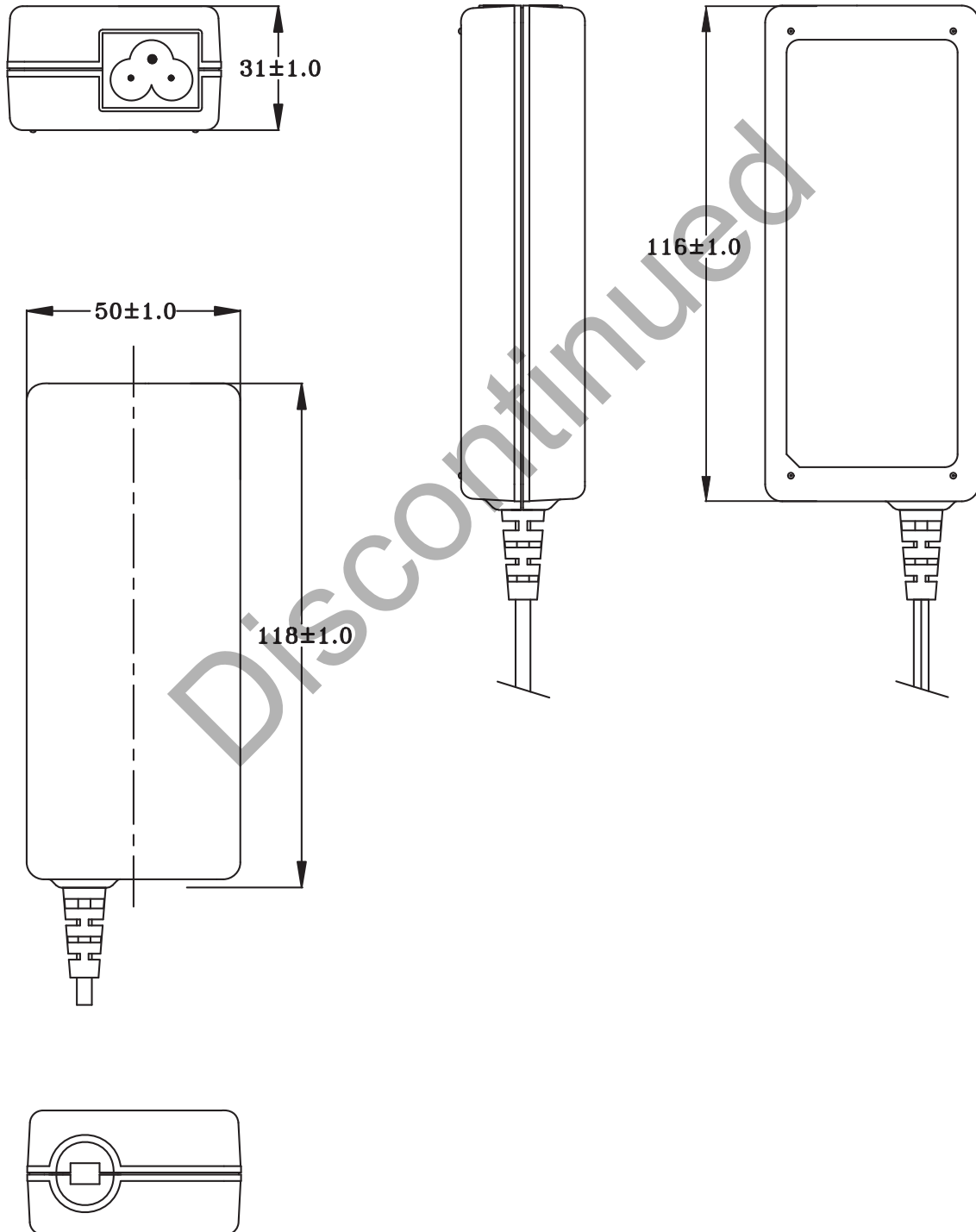



SERIES: 60 W DESKTOP

DESCRIPTION: SWITCHING POWER SUPPLY

DC CORD

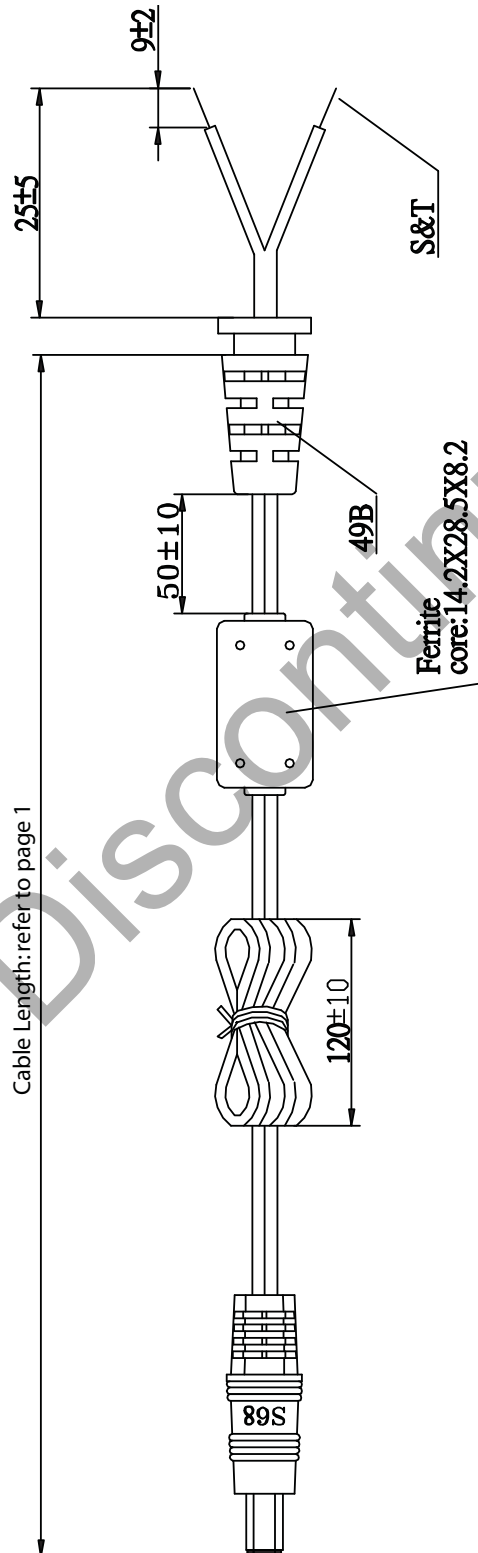

Black wire, white stripe: Positive

Cable Gauge	
ETS120500	18 AWG
ETS150400	18 AWG
ETS190315	18 AWG
ETS240250	18 AWG



SERIES: 60 W DESKTOP

DESCRIPTION: SWITCHING POWER SUPPLY

OUTPUT PLUG OPTIONS

3.5 mm Phono Plug

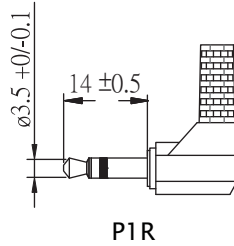
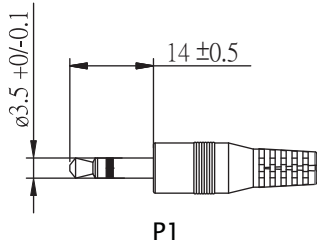

*Tip positive

Standard DC Plug

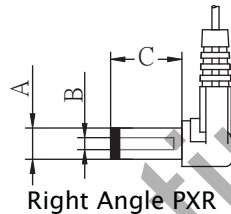
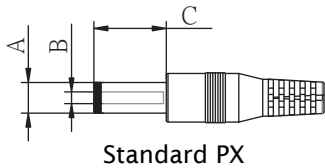

	A	B	C	Unit
P5/P5R	5.5	2.1	12	mm
P6/P6R	5.5	2.5	12	mm
P7/P7R	3.5	1.3	9.5	mm
P8/P8R	3.8	1.35	9.5	mm
P9/P9R	3.8	1.05	9.5	mm

Locking DC Plug

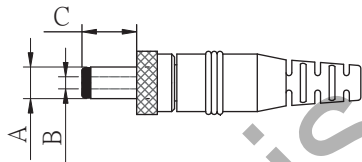

	A	B	C	Unit
P10	5.5	2.1	9.5	mm
P11	5.5	2.5	9.5	mm

EIAJ Plugs

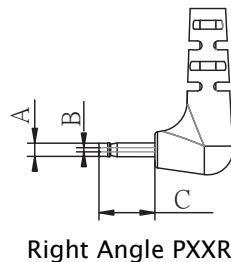
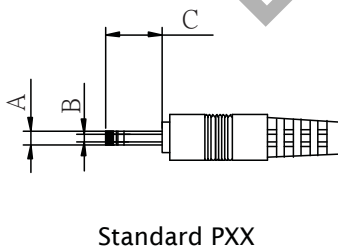

	EIAJ	A	B	C	D	Unit
P12/P12R	EIAJ-1	2.35	0.7	9.5	NA	mm
P13/P13R	EIAJ-2	4.0	1.7	9.5	5.0	mm
P14/P14R	EIAJ-3	4.75	1.7	9.5	5.0	mm

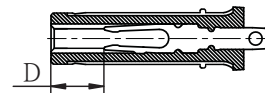

PART NUMBER GUIDE

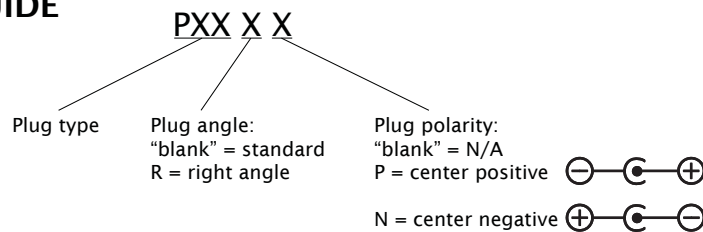

*Contact CUI for additional output plug options.



V-INFINITY
a division of CUI INC

date 03/2010
page 6 of 8

SERIES: 60 W DESKTOP

DESCRIPTION: SWITCHING POWER SUPPLY

AC CORD

C6

C14

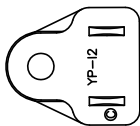
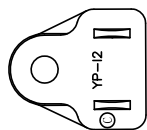
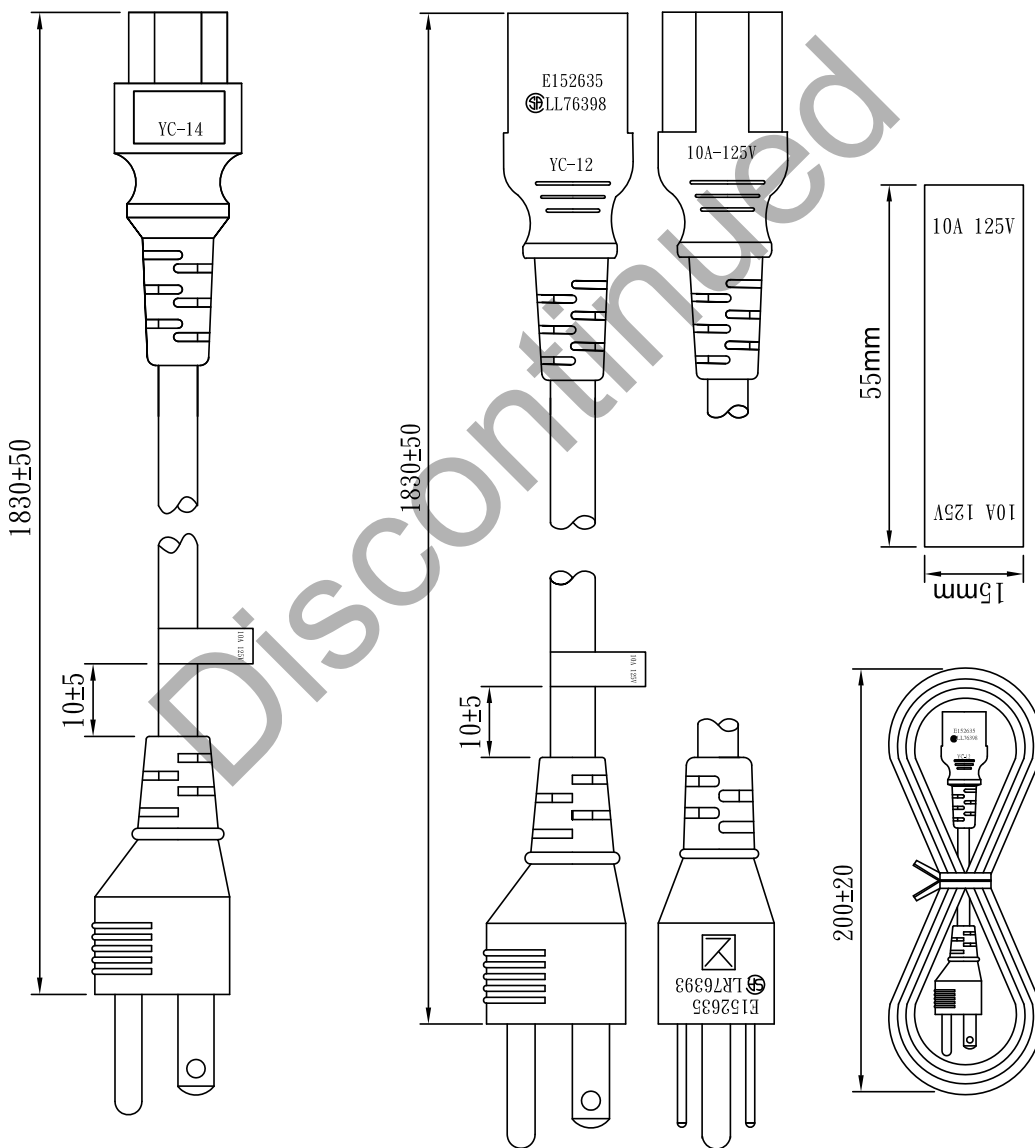
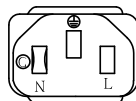
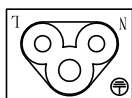

*Contact CUI for additional ac cord input blade options.



V-INFINITY
a division of CUI INC

date 03/2010

page 7 of 8

SERIES: 60 W DESKTOP

DESCRIPTION: SWITCHING POWER SUPPLY

INDIVIDUAL PACKAGING

tolerance ± 1 mm

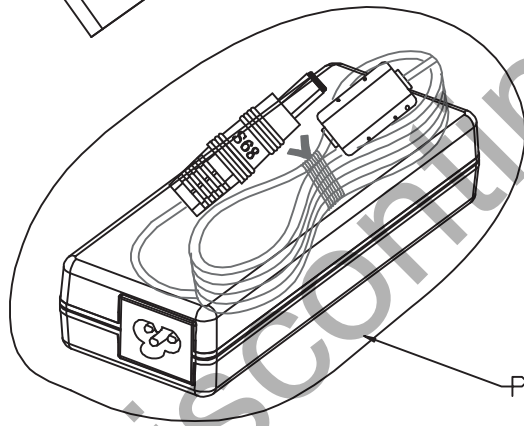
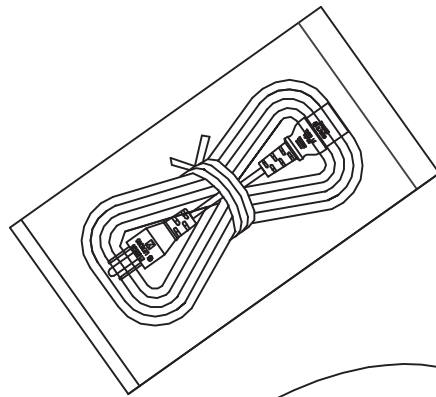

PE BAG(SIZE:200*150)

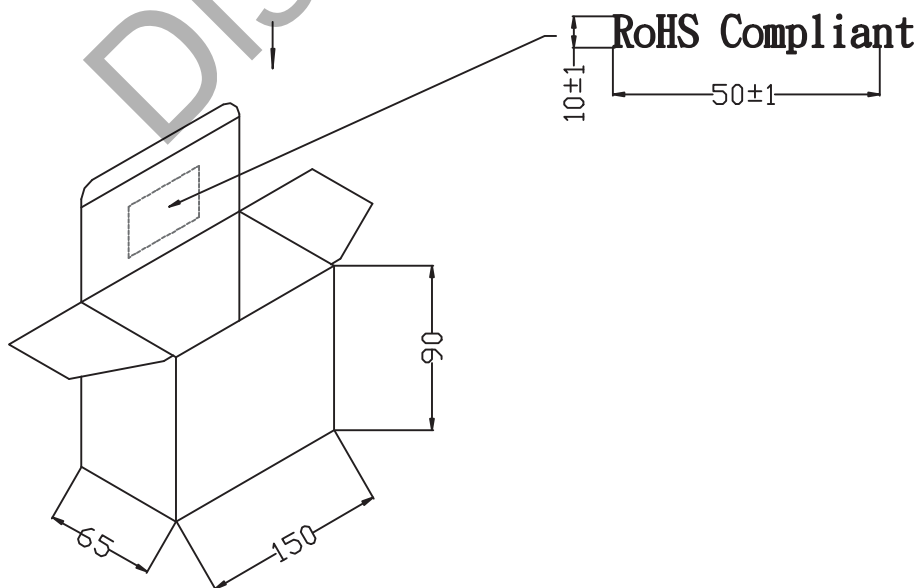



V-INFINITY
a division of CUI INC

date 03/2010

page 8 of 8

SERIES: 60 W DESKTOP

DESCRIPTION: SWITCHING POWER SUPPLY

PACKAGING

tolerance +7 / -0 mm

CARTON SIZE: 480X477X167mm

Q'TY: 30pcs(15x2x1)

"RoHS Compliant"

