

SERIES: PDM1-S | **DESCRIPTION:** DC-DC CONVERTER

FEATURES

- 1 W isolated output
- smaller package
- single/dual unregulated output
- 1,500 Vdc isolation
- short circuit protection
- extended temperature range (-40~105°C)
- antistatic protection up to 8kV
- high efficiency at light load
- efficiency up to 80%

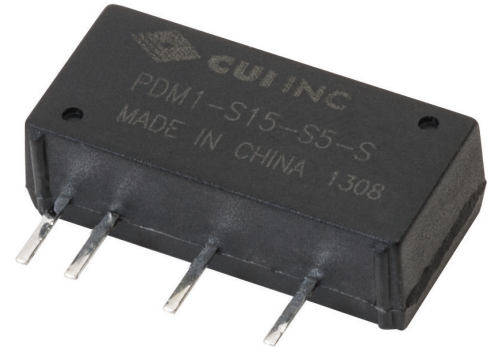

MODEL	input voltage		output voltage (Vdc)	output current		output power max (W)	ripple and noise ² typ (mVp-p)	efficiency typ (%)
	typ (Vdc)	range (Vdc)		min (mA)	max (mA)			
PDM1-S3-S3-S*	3.3	2.97~3.63	3.3	31	303	1	60	72
PDM1-S3-S5-S*	3.3	2.97~3.63	5	20	200	1	60	78
PDM1-S3-S9-S*	3.3	2.97~3.63	9	11	111	1	60	78
PDM1-S3-S12-S*	3.3	2.97~3.63	12	9	84	1	60	78
PDM1-S3-S15-S*	3.3	2.97~3.63	15	7	67	1	60	78
PDM1-S3-D5-S*	3.3	2.97~3.63	±5	±10	±100	1	60	78
PDM1-S3-D12-S*	3.3	2.97~3.63	±12	±5	±42	1	60	78
PDM1-S3-D15-S*	3.3	2.97~3.63	±15	±4	±34	1	60	76
PDM1-S5-S3-S*	5	4.5~5.5	3.3	31	303	1	60	74
PDM1-S5-S5-S ^{1,*}	5	4.5~5.5	5	20	200	1	60	80
PDM1-S5-S9-S ^{1,*}	5	4.5~5.5	9	11	111	1	60	80
PDM1-S5-S12-S ^{1,*}	5	4.5~5.5	12	9	84	1	60	80
PDM1-S5-S15-S ^{1,*}	5	4.5~5.5	15	7	67	1	60	80
PDM1-S5-S24-S ^{1,*}	5	4.5~5.5	24	5	42	1	60	80
PDM1-S5-D3-S	5	4.5~5.5	±3.3	±15	±152	1	60	71
PDM1-S5-D5-S ^{1,*}	5	4.5~5.5	±5	±10	±100	1	60	80
PDM1-S5-D9-S ^{1,*}	5	4.5~5.5	±9	±6	±56	1	60	80
PDM1-S5-D12-S ¹	5	4.5~5.5	±12	±5	±42	1	60	80
PDM1-S5-D15-S ¹	5	4.5~5.5	±15	±4	±34	1	60	80
PDM1-S5-D24-S ^{1,*}	5	4.5~5.5	±24	±3	±21	1	60	80
PDM1-S9-D9-S*	9	8.1~9.9	±9	±6	±56	1	60	80
PDM1-S9-D15-S*	9	8.1~9.9	±15	±4	±34	1	60	80
PDM1-S12-S3-S*	12	10.8~13.2	3.3	31	303	1	60	76
PDM1-S12-S5-S ¹	12	10.8~13.2	5	20	200	1	60	80
PDM1-S12-S9-S ^{1,*}	12	10.8~13.2	9	11	111	1	60	80
PDM1-S12-S12-S ^{1,*}	12	10.8~13.2	12	9	84	1	60	80
PDM1-S12-S15-S ^{1,*}	12	10.8~13.2	15	7	67	1	60	80

Notes: 1. UL approved
 2. Ripple and noise are measured at 20 MHz BW by "parallel cable" method with 1 μF ceramic and 10 μF electrolytic capacitors on the output.
 3. * Discontinued model.

MODEL (CONTINUED)	input voltage		output voltage	output current		output power	ripple and noise ²	efficiency
	typ (Vdc)	range (Vdc)	(Vdc)	min (mA)	max (mA)	max (W)	typ (mVp-p)	typ (%)
PDM1-S12-S24-S ^{1,*}	12	10.8~13.2	24	5	42	1	60	80
PDM1-S12-D3-S*	12	10.8~13.2	±3.3	±15	±152	1	60	76
PDM1-S12-D5-S ^{1,*}	12	10.8~13.2	±5	±10	±100	1	60	80
PDM1-S12-D9-S ^{1,*}	12	10.8~13.2	±9	±6	±56	1	60	80
PDM1-S12-D12-S ¹	12	10.8~13.2	±12	±5	±42	1	60	80
PDM1-S12-D15-S ¹	12	10.8~13.2	±15	±4	±34	1	60	80
PDM1-S12-D24-S ^{1,*}	12	10.8~13.2	±24	±3	±21	1	60	80
PDM1-S15-S5-S*	15	13.5~16.5	5	20	200	1	60	80
PDM1-S15-S9-S*	15	13.5~16.5	9	11	111	1	60	80
PDM1-S15-S12-S*	15	13.5~16.5	12	9	84	1	60	80
PDM1-S15-S15-S*	15	13.5~16.5	15	7	67	1	60	80
PDM1-S15-S24-S*	15	13.5~16.5	24	5	42	1	60	80
PDM1-S15-D5-S*	15	13.5~16.5	±5	±10	±100	1	60	80
PDM1-S15-D9-S*	15	13.5~16.5	±9	±6	±56	1	60	80
PDM1-S15-D12-S*	15	13.5~16.5	±12	±5	±42	1	60	80
PDM1-S15-D15-S*	15	13.5~16.5	±15	±4	±34	1	60	80
PDM1-S15-D24-S*	15	13.5~16.5	±24	±3	±21	1	60	80
PDM1-S24-S3-S*	24	21.6~26.4	3.3	31	303	1	60	74
PDM1-S24-S5-S ^{1,*}	24	21.6~26.4	5	20	200	1	60	80
PDM1-S24-S9-S ^{1,*}	24	21.6~26.4	9	11	111	1	60	80
PDM1-S24-S12-S ^{1,*}	24	21.6~26.4	12	9	84	1	60	80
PDM1-S24-S15-S ^{1,*}	24	21.6~26.4	15	7	67	1	60	80
PDM1-S24-S24-S ¹	24	21.6~26.4	24	5	42	1	60	80
PDM1-S24-D5-S ^{1,*}	24	21.6~26.4	±5	±10	±100	1	60	80
PDM1-S24-D9-S ^{1,*}	24	21.6~26.4	±9	±6	±56	1	60	80
PDM1-S24-D12-S ¹	24	21.6~26.4	±12	±5	±42	1	60	80
PDM1-S24-D15-S ^{1,*}	24	21.6~26.4	±15	±4	±34	1	60	80
PDM1-S24-D24-S ^{1,*}	24	21.6~26.4	±24	±3	±21	1	60	80

Notes: 1. UL approved
 2. Ripple and noise are measured at 20 MHz BW by "parallel cable" method with 1 µF ceramic and 10 µF electrolytic capacitors on the output.
 3. * Discontinued model.

PART NUMBER KEY

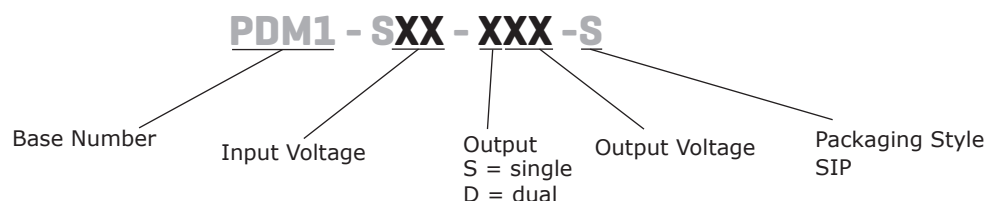

INPUT

parameter	conditions/description	min	typ	max	units
operating input voltage	3.3 Vdc input models	2.97	3.3	3.63	Vdc
	5 Vdc input models	4.5	5	5.5	Vdc
	9 Vdc input models	8.1	9	9.9	Vdc
	12 Vdc input models	10.8	12	13.2	Vdc
	15 Vdc input models	13.5	15	16.5	Vdc
	24 Vdc input models	21.6	24	26.4	Vdc
surge voltage	for maximum of 1 second				
	3.3 Vdc input models	-0.7		5	Vdc
	5 Vdc input models	-0.7		9	Vdc
	9 Vdc input models	-0.7		12	Vdc
	12 Vdc input models	-0.7		18	Vdc
	15 Vdc input models	-0.7		21	Vdc
24 Vdc input models	-0.7		30	Vdc	
filter	capacitance filter				

OUTPUT

parameter	conditions/description	min	typ	max	units
line regulation	for Vin change of 1%				
	3.3 Vdc output models			±1.5	%
	all other models			±1.2	%
load regulation	measured from 10% load to full load				
	3.3 Vdc output models		18		%
	5 Vdc output models		12		%
	9 Vdc output models		9		%
	12 Vdc output models		8		%
	15 Vdc output models		7		%
24 Vdc output models		6		%	
voltage accuracy	see tolerance envelope curve				
switching frequency	100% load, nominal input voltage		100		kHz
temperature coefficient	100% load			±0.03	%/°C

PROTECTIONS

parameter	conditions/description	min	typ	max	units
short circuit protection ¹	3.3 Vdc input single output models, 24 Vdc input single/dual output models, PDM1-S5-S24-S, PDM1-S5-D24-S, PDM1-S3-D15-S all other models: continuous, auto recovery			1	s

Notes: 1. The supply voltage must be discontinued at the end of the short circuit duration

SAFETY AND COMPLIANCE

parameter	conditions/description	min	typ	max	units
isolation voltage	input to output, for 1 minute at 1 mA max.	1,500			Vdc
isolation resistance	input to output at 500 Vdc	1,000			MΩ
isolation capacitance	input to output at 100kHz/0.1V		20		pF
safety approvals ²	certified to 60950: EN certified to 60950-1: UL				
conducted emissions	CISPR32/EN55032 class B (external circuit required, see Figure 1)				
radiated emissions	CISPR32/EN55032 class B (external circuit required, see Figure 1)				
ESD	IEC/EN61000-4-2, class B, contact ± 8kV for single outputs IEC/EN61000-4-2, class B, contact ± 6kV for dual outputs				
MTBF	as per MIL-HDBK-217F at 25°C	3,500,000			hours
RoHS	yes				

Notes: 2. See specific models noted on pages 1 and 2

ENVIRONMENTAL

parameter	conditions/description	min	typ	max	units
operating temperature	see derating curve	-40		105	°C
storage temperature		-55		125	°C
storage humidity	non-condensing			95	%
temperature rise	Ta = 25°C		25		°C

SOLDERABILITY

parameter	conditions/description	min	typ	max	units
hand soldering	1.5 mm from case for 10 seconds			300	°C
wave soldering	see wave soldering profile			260	°C

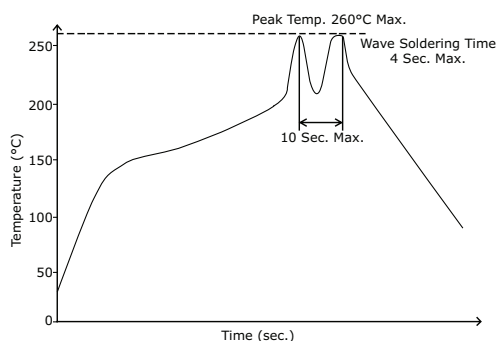

MECHANICAL

parameter	conditions/description	min	typ	max	units
dimensions	19.50 x 6.00 x 9.30 (0.768 x 0.236 x 0.366 inch)				mm
case material	epoxy resin (UL94-V0)				
weight			2.4		g

MECHANICAL DRAWING

units: mm[inch]
tolerance: ±0.25[±0.010]
pin section tolerance: ±0.10[±0.004]

PIN CONNECTIONS		
PIN	Single Output	Dual Output
1	Vin	Vin
2	GND	GND
4	0V	-Vo
5	No Pin	0V
6	+Vo	+Vo

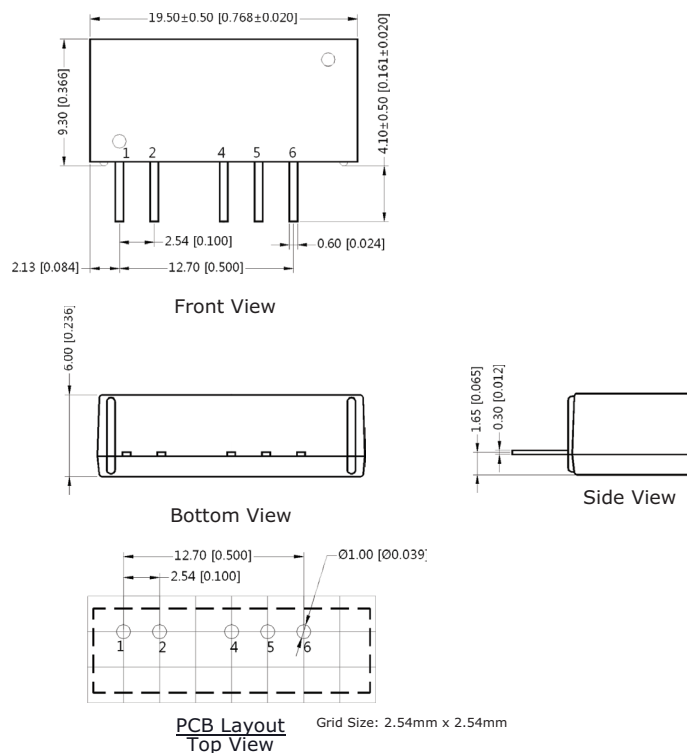

DERATING CURVES

OUTPUT REGULATION CURVE
3.3 Vdc output model
(nominal input)

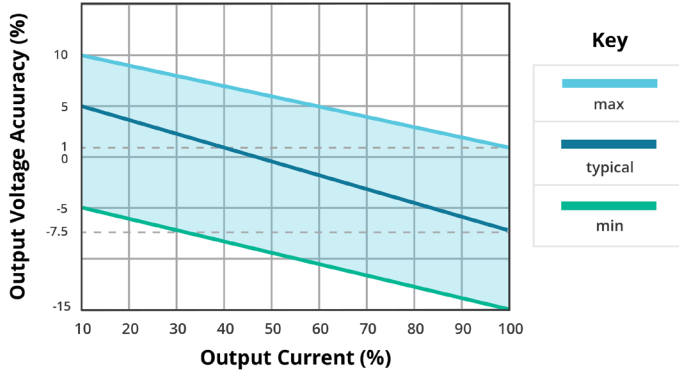

OUTPUT REGULATION CURVE
all other output models
(nominal input)

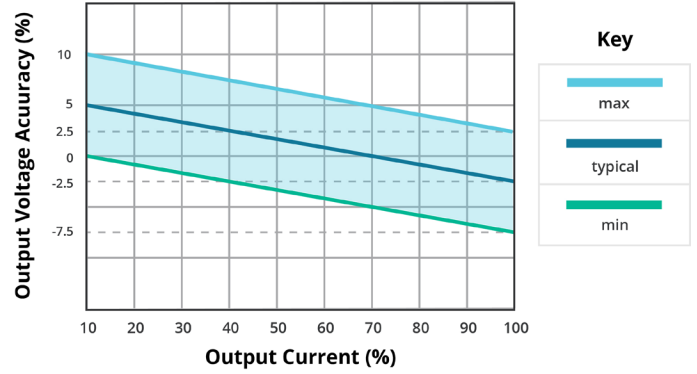

TEMPERATURE DERATING CURVE

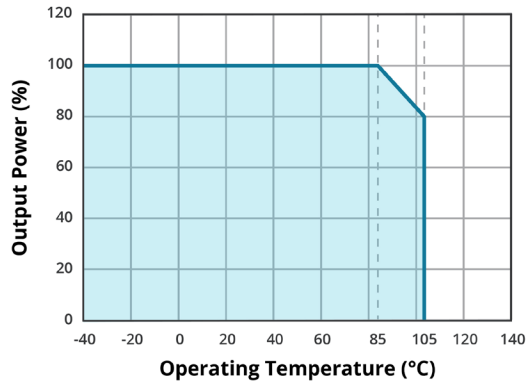

EMC RECOMMENDED CIRCUIT

Figure 1

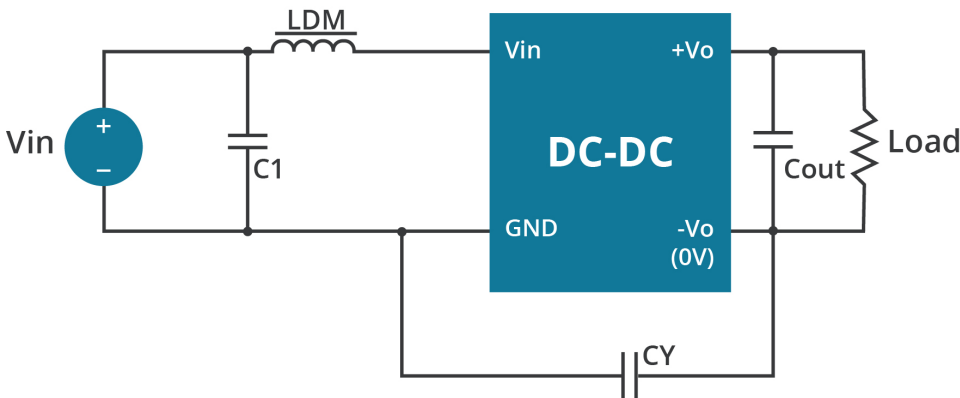

Table 1

Recommended external circuit components			
Vin (Vdc)	C1	CY	LDM
3.3	4.7μF/50V	--	6.8μH
5	4.7μF/50V	--	6.8μH
9	4.7μF/50V	--	6.8μH
12	4.7μF/50V	--	6.8μH
15	4.7μF/50V	1nF/2KV	6.8μH
24	4.7μF/50V	1nF/2KV	6.8μH

Note: 1. See Table 2 for Cout values.

APPLICATION NOTES

1. Output load requirement

To ensure this module can operate efficiently and reliably, the minimum output load may not be less than 10% of the full load during operation. If the actual output power is low, connect a resistor at the output end in parallel to increase the load.

2. Recommended circuit

If you want to further decrease the input/output ripple, you can increase the capacitance accordingly or choose capacitors with low ESR (see Figure 2 & Table 2). However, the capacitance of the output filter capacitor must be appropriate. If the capacitance is too high, a startup problem might arise. For every channel of the output, to ensure safe and reliable operation, the maximum capacitance must be less than the maximum capacitive load (see Table 3).

Figure 2

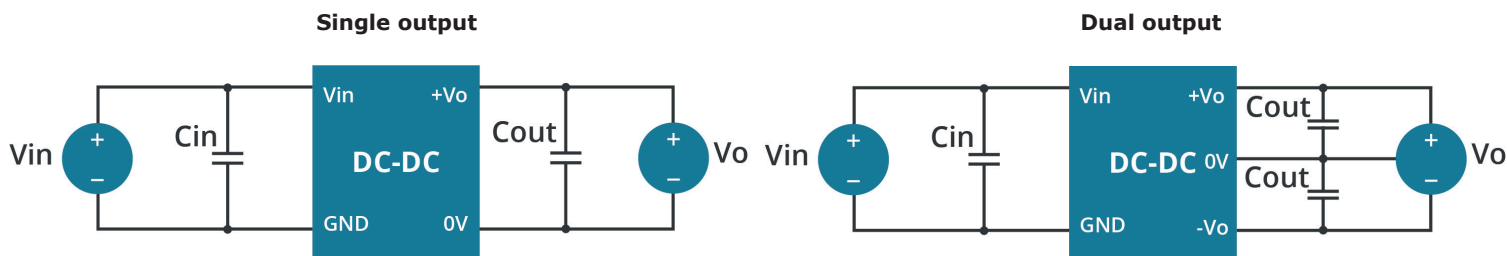

Table 2

Vin (Vdc)	Cin (μF)	Single Vo (Vdc)	Cout (μF)	Dual Vo (Vdc)	Cout (μF)
3.3	4.7	3.3	10	±3.3	4.7
5	4.7	5	10	±5	4.7
9	2.2	9	2.2	±9	1
12	2.2	12	2.2	±12	1
15	2.2	15	1	±15	0.47
24	1	24	1	±24	0.47

Note: It's not recommended to connect any external capacitors in applications with less than 0.5 watt output.

Table 3

Single Vout (Vdc)	Max. Capacitive Load (μF)	Dual Vout (Vdc)	Max. Capacitive Load ¹ (μF)
3.3	220	3.3	100
5	220	5	100
9	220	9	100
12	220	12	100
15	220	15	100
24	220	24	100

Note: 1. For each output.

Note: 1. Operation under minimum load will not damage the converter; however, they may not meet all specifications listed.
 2. Max. capacitive load tested at input voltage range and full load.
 3. All specifications measured at: Ta=25°C, humidity<75%, nominal input voltage and rated output load, unless otherwise specified.

REVISION HISTORY

rev.	description	date
1.0	initial release	03/18/2013
1.01	added models, added UL approval to some models	11/14/2014
1.02	added UL approval to some models	02/10/2015
1.03	updated tolerance envelope curves	09/12/2018
1.04	safeties updated in features and safety line	01/18/2021
1.05	derating curves and circuit figures updated	07/01/2021
1.06	CE removed	10/27/2022
1.07	discontinued model PDM1-S3-D5-S, PDM1-S5-D24-S, PDM1-S5-S24-S, PDM1-S9-D15-S	12/14/2022
1.08	discontinued model PDM1-S5-S3-S, PDM1-S5-S9-S, PDM1-S5-S12-S & PDM1-S15-S9-S	02/02/2023
1.09	updated safeties	02/10/2023
1.10	discontinued models	06/29/2023

The revision history provided is for informational purposes only and is believed to be accurate.



CUI INC
a bel group

Headquarters
20050 SW 112th Ave.
Tualatin, OR 97062
800.275.4899

Fax 503.612.2383
cui.com
techsupport@cui.com

CUI offers a two (2) year limited warranty. Complete warranty information is listed on our website.

CUI reserves the right to make changes to the product at any time without notice. Information provided by CUI is believed to be accurate and reliable. However, no responsibility is assumed by CUI for its use, nor for any infringements of patents or other rights of third parties which may result from its use.

CUI products are not authorized or warranted for use as critical components in equipment that requires an extremely high level of reliability. A critical component is any component of a life support device or system whose failure to perform can be reasonably expected to cause the failure of the life support device or system, or to affect its safety or effectiveness.