

SERIES: PDP1-M | **DESCRIPTION:** DC-DC CONVERTER

FEATURES

- 1W isolated output
- 1500 Vdc isolation
- compact SMD package
- continuous short circuit protection
- no-load input current as low as 5mA
- wide temperature range: -40°C to +105°C
- high efficiency up to 83%
- UL 62368 certified
- designed to meet EN/BS EN 62368



MODEL	input voltage		output voltage (Vdc)	output current		output power max (W)	ripple and noise ¹ max (mVp-p)	efficiency typ (%)
	typ (Vdc)	range (Vdc)		min (mA)	max (mA)			
PDP1-S5-S3-M	5	4.5~5.5	3.3	30	303	1	75	74
PDP1-S5-S5-M	5	4.5~5.5	5	20	200	1	75	82
PDP1-S5-S9-M	5	4.5~5.5	9	12	111	1	75	83
PDP1-S5-S12-M	5	4.5~5.5	12	9	84	1	75	83

Notes: 1. Ripple & noise testing condition at nominal input voltage and 10~100% load, 20 MHz bandwidth.

PART NUMBER KEY

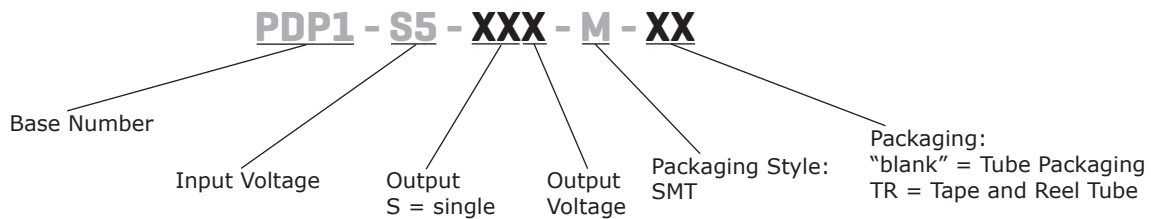

INPUT

parameter	conditions/description	min	typ	max	units
input voltage		4.5	5	5.5	Vdc
surge voltage	for maximum of 1 second	-0.7		9	Vdc
filter	capacitance filter				
current	full load/no load 3.3/5 Vdc input models 9/12 Vdc input models		270/5 241/12	286/10 254/20	mA mA

OUTPUT

parameter	conditions/description	min	typ	max	units
line regulation	Vin change $\pm 1\%$ 3.3 Vdc output other outputs			1.5 1.2	% %
load regulation	10% ~ 100% load 3.3 Vdc output 5 Vdc output 9 Vdc output 12 Vdc output		15 10 8 7	20 15 10 10	% % % %
set-point accuracy	see regulation curve				
switching frequency	full load, nominal input		270		kHz
temperature coefficient	full load			± 0.02	%/°C

PROTECTIONS

parameter	conditions/description	min	typ	max	units
short circuit protection	Continuous, self-recovery				

SAFETY AND COMPLIANCE

parameter	conditions/description	min	typ	max	units
isolation voltage	input-output electric strength test for 1 minute	1500			Vdc
isolation resistance	input-output insulation at 500 Vdc	1000			MΩ
isolation capacitance	input-output capacitance at 100 KHz / 0.1 V		20		pF
safety approvals	certified to 62368: UL designed to meet 62368: EN/BS EN				
EMC	CISPR32/EN55032 Class B (see recommended circuit)				
ESD	IEC/EN61000-4-2, Air ±8kV, Contact ±4kV, perf. Criteria B				
RoHS	yes				
MTBF	MIL-HDBK-217F @ 25°C	3500			kHours

ENVIRONMENTAL

parameter	conditions/description	min	typ	max	units
operating temperature		-40		105	°C
storage temperature		-55		125	°C
humidity	non-condensing	5		95	%

SOLDERABILITY

parameter	conditions/description	min	typ	max	units
reflow soldering	60 s max over 217°C			245	°C

DERATING CURVES

OUTPUT REGULATION CURVE
3.3 Vdc output model
(nominal input)

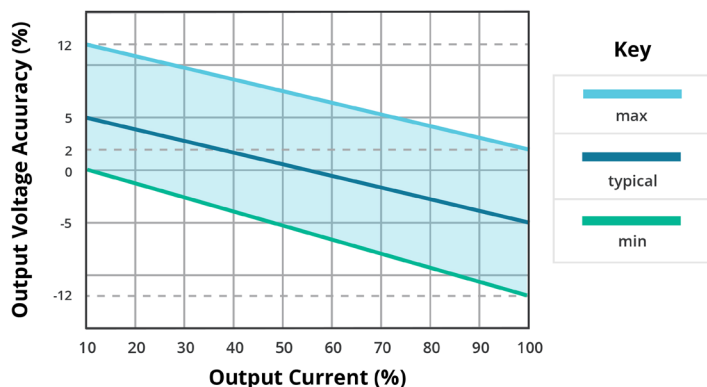

OUTPUT REGULATION CURVE
all other output models
(nominal input)

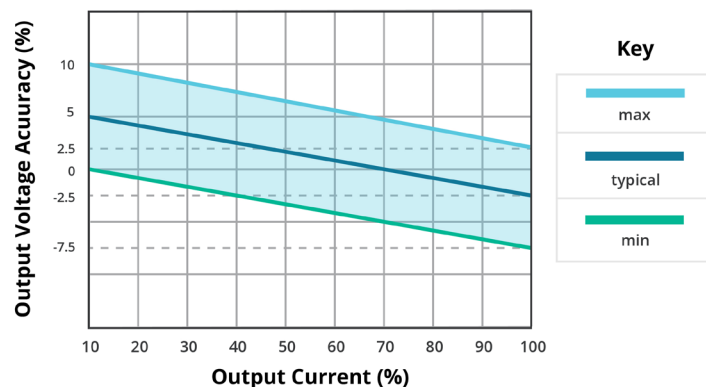

TEMPERATURE DERATING CURVE

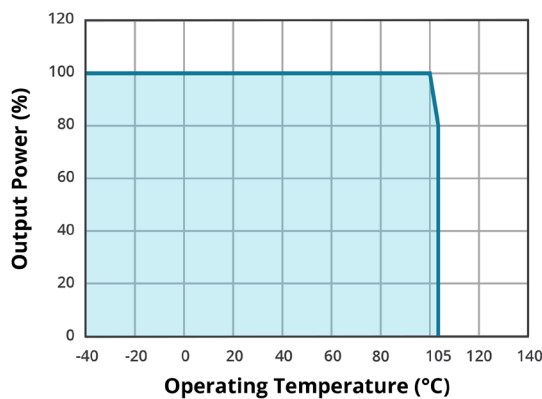

MECHANICAL

parameter	conditions/description	min	typ	max	units
dimensions	13.20 x 11.40 x 7.25				mm
case material	Black plastic; flame-retardant and heat-resistant (UL94 V-0)				
weight			1.3		g

MECHANICAL DRAWING

units: mm [inches]
 tolerance: ± 0.50 [± 0.020]

PIN CONNECTIONS	
PIN	FUNCTION
1	GND
2	Vin
4	0V
5	+Vo
3, 6, 7, 8	NC

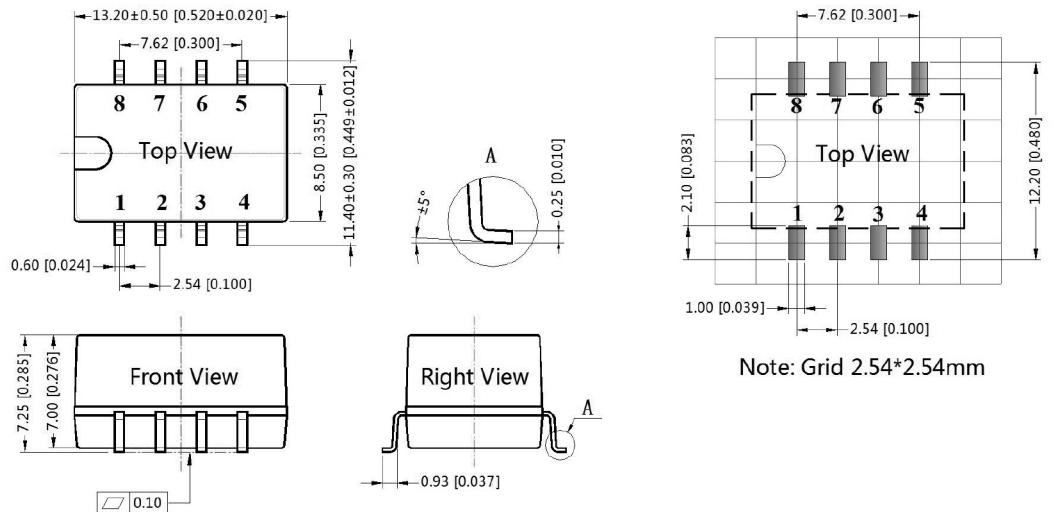

RECOMMENDED CIRCUITS

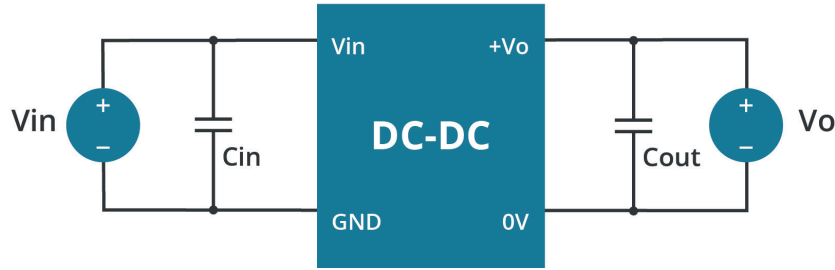

recommended input & output capacitor values			
V_{in} (Vdc)	C_{in} (μF)	V_o (Vdc)	C_{out} (μF)
5	4.7	3.3/5	10
		9	4.7
		12	2.2

EMC COMPLIANCE CIRCUITS

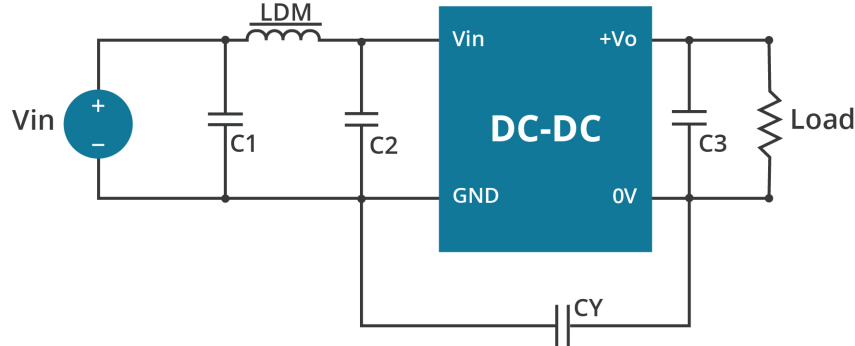

Recommended EMC Filter Values				
Input voltage 5 Vdc	Output Voltage (Vdc)	3.3/5/9	12	
	Emmissions	C1/C2	47 μF / 25V	47 μF / 25V
		CY	- -	1nF/2KVDC HEC C1206X102K202T JOHANSON 202R18W102KV4E
		C3	refer to the C_{out} in table 1	
		LDM	6.8 μH	6.8 μH

Note: To further improve EMI performance, we recommend the use a Y-capacitor C_Y

REVISION HISTORY

rev.	description	date
1.0	initial release	03/28/2020
1.01	derating curves and circuit figures updated	06/30/2021
1.02	measurements corrected in the mechanical section	01/10/2022
1.03	CE removed	11/04/2022
1.04	pn key updated	05/16/2023

The revision history provided is for informational purposes only and is believed to be accurate.



Headquarters
20050 SW 112th Ave.
Tualatin, OR 97062
800.275.4899

Fax 503.612.2383
cui.com
techsupport@cui.com

CUI offers a two (2) year limited warranty. Complete warranty information is listed on our website.

CUI reserves the right to make changes to the product at any time without notice. Information provided by CUI is believed to be accurate and reliable. However, no responsibility is assumed by CUI for its use, nor for any infringements of patents or other rights of third parties which may result from its use.

CUI products are not authorized or warranted for use as critical components in equipment that requires an extremely high level of reliability. A critical component is any component of a life support device or system whose failure to perform can be reasonably expected to cause the failure of the life support device or system, or to affect its safety or effectiveness.