

**SERIES: VDSD1-DIP | DESCRIPTION: DC-DC CONVERTER**
**FEATURES**

- 1 W isolated output
- industry standard 14 pin DIP package
- dual unregulated outputs
- 1,000 V isolation
- short circuit protection
- UL safety approvals
- wide temperature (-40~85°C)
- efficiency up to 81%



MODEL	input voltage		output voltage (Vdc)	output current		output power max (W)	ripple and noise <sup>1</sup> max (mVp-p)	efficiency typ (%)	UL60950-1
	typ (Vdc)	range (Vdc)		min (mA)	max (mA)				
VDSD1-S5-DI5-DIP	5	4.5~5.5	±5	±10	±100	1	75	72	YES
VDSD1-S5-DI9-DIP	5	4.5~5.5	±9	±6	±56	1	75	75	YES
VDSD1-S5-DI12-DIP	5	4.5~5.5	±12	±4	±42	1	75	78	YES
VDSD1-S5-DI15-DIP	5	4.5~5.5	±15	±3	±33	1	75	79	YES
VDSD1-S12-DI5-DIP	12	10.8~13.2	±5	±10	±100	1	75	74	YES
VDSD1-S12-DI9-DIP	12	10.8~13.2	±9	±6	±56	1	75	76	YES
VDSD1-S12-DI12-DIP	12	10.8~13.2	±12	±4	±42	1	75	79	YES
VDSD1-S12-DI15-DIP	12	10.8~13.2	±15	±3	±33	1	75	80	YES
VDSD1-S15-DI5-DIP	15	13.5~16.5	±5	±10	±100	1	75	74	NO
VDSD1-S15-DI9-DIP	15	13.5~16.5	±9	±6	±56	1	75	75	NO
VDSD1-S15-DI12-DIP	15	13.5~16.5	±12	±4	±42	1	75	79	NO
VDSD1-S15-DI15-DIP	15	13.5~16.5	±15	±3	±33	1	75	79	NO
VDSD1-S24-DI5-DIP	24	21.6~26.4	±5	±10	±100	1	75	74	YES
VDSD1-S24-DI9-DIP	24	21.6~26.4	±9	±6	±56	1	75	76	YES
VDSD1-S24-DI12-DIP	24	21.6~26.4	±12	±4	±42	1	75	80	YES
VDSD1-S24-DI15-DIP	24	21.6~26.4	±15	±3	±33	1	75	81	YES

Notes: 1. ripple and noise are measured at 20 MHz BW

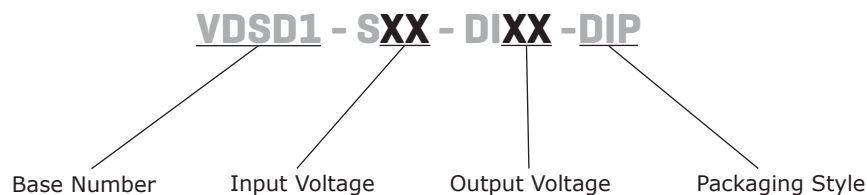
**PART NUMBER KEY**

**INPUT**

parameter	conditions/description	min	typ	max	units
operating input voltage	5 V model	4.5	5	5.5	Vdc
	12 V model	10.8	12	13.2	Vdc
	15 V model	13.5	15	16.5	Vdc
	24 V model	21.6	24	26.4	Vdc

**OUTPUT**

parameter	conditions/description	min	typ	max	units
line regulation	for Vin change of 1%			1.2	%
load regulation	measured from 10% load to full load			15	%
voltage accuracy	see derating curves				
switching frequency	100% load, input voltage range	80	100	200	kHz
temperature coefficient			±0.03		%/°C

**PROTECTIONS**

parameter	conditions/description	min	typ	max	units
short circuit protection				1	s

**SAFETY AND COMPLIANCE**

parameter	conditions/description	min	typ	max	units
isolation voltage	for 1 minute at 1 mA max.	1,000			Vdc
isolation resistance	at 500 Vdc	1,000			MΩ
safety approvals <sup>1</sup>	UL 60950-1 (E222736)				
MTBF		3,500,000			hours
RoHS compliant	yes				
burn-in	full load at +85°C, for 4 hours at no-load and 4 hours at full load				

**ENVIRONMENTAL**

parameter	conditions/description	min	typ	max	units
operating temperature		-40		85	°C
storage temperature		-55		125	°C
storage humidity	non-condensing			95	%
temperature rise	at full load		15	25	°C
lead temperature	1.5 mm from case for 10 seconds			300	°C

## DERATING CURVES

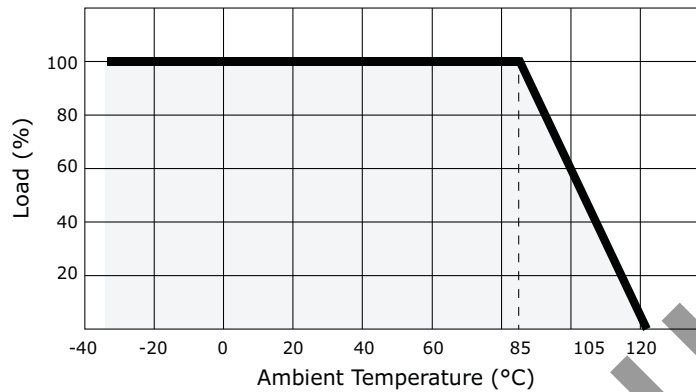

## MECHANICAL

parameter	conditions/description	min	typ	max	units
dimensions	20.40 x 10.00 x 7.00 (0.803 x 0.394 x 0.276 inch)				mm
case material	plastic (UL94-V0)				
weight			2.1		g

## MECHANICAL DRAWING

units: mm  
 tolerance:  $\pm 1$  mm  
 pin section tolerance:  $\pm 0.10$  mm

### Side View

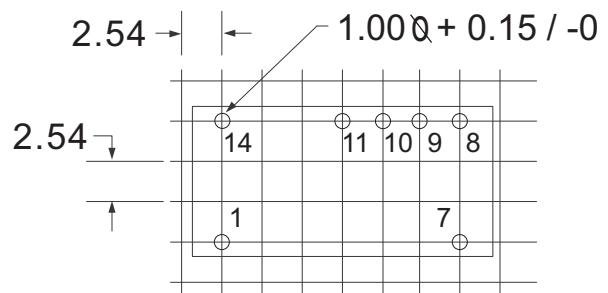
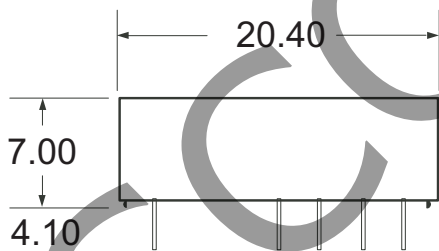

### Bottom View

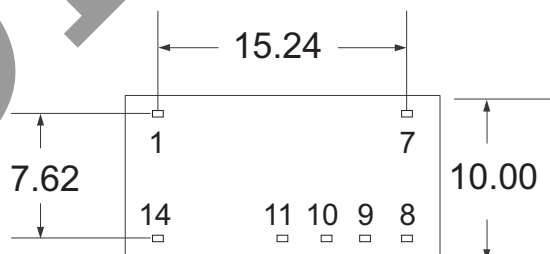

#### PIN CONNECTIONS

PIN	FUNCTION
1	-Vin
7	NC
8	+Vo2
9	-Vo2
10	+Vo2
11	-Vo2
14	+Vin

## APPLICATION NOTES

### 1. Input filtering

To reduce the reflected ripple current and minimize EMI, especially when the converter input is more than 2" away from the DC source, it is recommended to connect a low ESR electrolytic capacitor between Vin and Gnd. The values suggested are as shown in Table 1. If additional filtering is required, the capacitance may be increased, or expanded to an LC network as shown in Figure 1.

Table 1

Input Voltage	External Input Capacitance
5 V	4.7 $\mu$ F
12 V	2.2 $\mu$ F
15 V	2.2 $\mu$ F
24 V	1.0 $\mu$ F

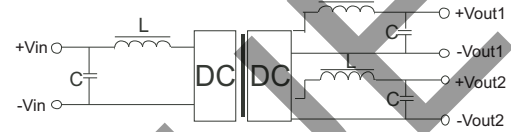

Figure 1

### 2. Output filtering

An output capacitor is needed to meet output ripple requirements as shown in Table 2. Output capacitance may be increased for additional filtering, but should not exceed 10 $\mu$ F or expanded to an LC network as in Figure 1.

Table 2

Output Voltage	External Input Capacitance
5 V	10 $\mu$ F
9 V	4.7 $\mu$ F
12 V	2.2 $\mu$ F
15 V	1.0 $\mu$ F
24 V	0.47 $\mu$ F

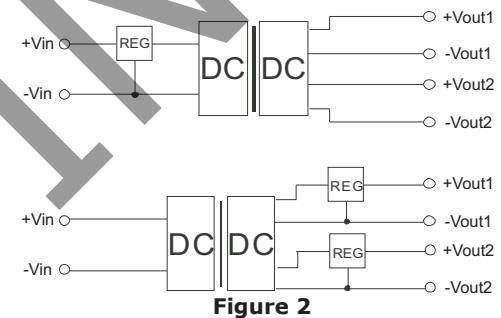

Figure 2

### 3. Minimum loading

The converter needs a minimum of 10% loading to maintain output regulation. Operation under no-load conditions will not cause immediate damages but may reduce reliability, and cause performance not to meet specifications.

### 4. Regulation

With a semi-regulated design, the converter's output voltage varies with load current and will change proportionally to the input voltage. If regulated output is needed, an external regulator can be used as shown in Figure 2.

### 5. Protection

The converter has minimal protection against input over-voltage or output over-load, and may be permanently damaged if exposed to these conditions. An input clamping device can be used for input voltage limiting. An input fuse or an output fuse can also be used to protect against over-loading.

### 6. Dual outputs used as a single output

The +Vout and -Vout can be used to obtain a single output that is the sum of the two outputs. In this case, the COM pin shouldn't be used.

### 7. External Regulator

An external 3-terminal regulator can be connected to the output of the converter to achieve full regulation. Make sure the converter's output voltage provides sufficient head room for the regulator. An additional benefit is that the built-in protection features in the regulator, such as OCP, OTP, etc, will protect the converter also. In a complimentary supply, a negative output regulator must be used to achieve the negative regulated output.

## REVISION HISTORY

rev.	description	date
1.0	initial release	05/12/2006
1.01	new template applied	09/04/2009
1.02	new template applied, V-Infinity branding removed	09/07/2012
1.03	corrected part numbers	11/29/2012
1.04	updated spec	07/11/2013

The revision history provided is for informational purposes only and is believed to be accurate.



**Headquarters**  
20050 SW 112th Ave.  
Tualatin, OR 97062  
**800.275.4899**

Fax 503.612.2383  
**cui.com**  
techsupport@cui.com

CUI offers a two (2) year limited warranty. Complete warranty information is listed on our website.

CUI reserves the right to make changes to the product at any time without notice. Information provided by CUI is believed to be accurate and reliable. However, no responsibility is assumed by CUI for its use, nor for any infringements of patents or other rights of third parties which may result from its use.

CUI products are not authorized or warranted for use as critical components in equipment that requires an extremely high level of reliability. A critical component is any component of a life support device or system whose failure to perform can be reasonably expected to cause the failure of the life support device or system, or to affect its safety or effectiveness.