

SERIES: VMS-45 | DESCRIPTION: AC-DC POWER SUPPLY**FEATURES**

- universal input voltage (80 to 264 Vac or 110 to 370 Vdc)
- wide operating temperature (-40°C ~ 85°C)
- meets 2 x MOPP safety certification
- over current, over temperature, and short circuit protections
- over voltage Class III
- certified to EN 60601 safety standards
- suitable for safety class II installations
- meets 5,000m altitude requirements
- low leakage current (< 75µA)
- low standby power consumption (0.3W)



MODEL	output voltage		output current	output power	ripple and noise ¹	efficiency ²
	nom (Vdc)	range (Vdc)	max (A)	max (W)	max (mVp-p)	typ (%)
VMS-45-3	3.3	2.97~3.63	8.0	26.4	100	83
VMS-45-5	5	4.5~5.5	8.0	40.0	100	85
VMS-45-12	12	10.2~13.8	3.75	45.0	100	90
VMS-45-15	15	13.5~18.0	3.0	45.0	100	90
VMS-45-24	24	21.6~28.5	1.875	45.0	120	90
VMS-45-36	36	32.4~39.6	1.25	45.0	150	90
VMS-45-48	48	43.2~52.8	0.94	45.0	150	90

- Notes:
1. At full load, nominal input, 20 MHz bandwidth oscilloscope, tip & barrel method, for 3.3V, 5V, 12V & 15V output terminated with 10 µF ceramic capacitor, for 24V output terminated with a 1µF ceramic capacitor, for 36V & 48V with a 0.1 ceramic capacitor. See Application notes.
 2. At 230 Vac.
 3. Unless otherwise specified, parameters in this datasheet were measured under the conditions of Ta=25°C humidity<75% with nominal input voltage and rated output load.

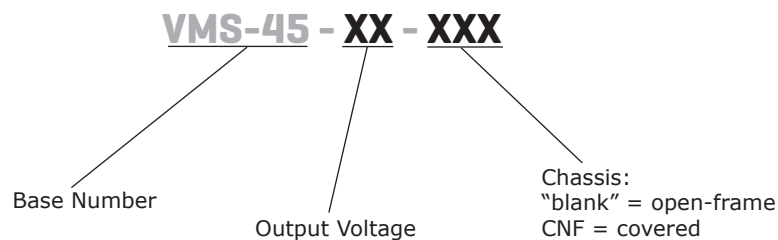
PART NUMBER KEY

INPUT

parameter	conditions/description	min	typ	max	units
voltage	ac input	80		264	Vac
	dc input	100		370	Vdc
frequency		47		63	Hz
current	at 115 Vac			1.1	A
	at 230 Vac			0.7	A
inrush current	at 115 Vac			40	A
	at 230 Vac			60	A
leakage current	at 240 Vac			0.075	mA
no load power consumption				0.3	W

OUTPUT

parameter	conditions/description	min	typ	max	units
output capacitance	3.3 & 5 Vdc output models			20,000	μF
	12 Vdc output model			4,000	μF
	15 Vdc output model			3,500	μF
	24 Vdc output model			1,000	μF
	36 Vdc output model			820	μF
	48 Vdc output model			330	μF
initial set point accuracy	0% ~ 100% load				
	3.3 & 5 Vdc output models		±2		%
	all other output models		±1		%
line regulation	at rated load				
	3.3 & 5 Vdc output models		±0.8		%
	all other output models		±0.5		%
load regulation	at 230 Vac		±1		%
hold-up time	at 115 Vac	13	22		ms
	at 230 Vac	65	100		ms
temperature coefficient			±0.02		%/°C

PROTECTIONS

parameter	conditions/description	min	typ	max	units
over voltage protection	output voltage hiccup				
	3.3 Vdc output model			5.25	Vdc
	5 Vdc output model			7.0	Vdc
	12 Vdc output model			16.0	Vdc
	15 Vdc output model			22.0	Vdc
	24 Vdc output model			32.4	Vdc
	36 Vdc output model			42.4	Vdc
48 Vdc output model			57.0	Vdc	
over current protection	auto recovery	120			%
short circuit protection	continuous, auto recovery, hiccup				

SAFETY & COMPLIANCE

parameter	conditions/description	min	typ	max	units
isolation voltage	input to output for 1 minute, 5 mA max	4,000			Vac
	input to case (-CNF only) for 1 minute, 5 mA max	2,500			Vac
	output to ground for 1 minute, 5 mA max	2,500			Vac
safety approvals	EN60601-1 Edition 3.1 CAN/CSA 22.2 No.60601-1:14 Edition 3 EN60601-1-2 Edition 4				
safety class	Class II				
conducted emissions	CISPR32/EN55032/EN55011 CLASS B				
radiated emissions	CISPR32/EN55032/EN55011 CLASS B				
ESD	IEC/EN61000-4-2 Contact ±8KV/ Air ±15KV, perf. Criteria A				
radiated immunity	IEC/EN61000-4-3 20V/m, perf. Criteria A				
EFT/burst	IEC/EN61000-4-4 ±2KV, perf. Criteria A				
surge	IEC/EN61000-4-5 Line to line ±2KV, perf. Criteria A				
conducted immunity	IEC/EN61000-4-6 20 Vr.m.s, perf. Criteria A				
voltage dips and interruptions	IEC/EN61000-4-11 100% dip 1 periods, 30% dip 25 periods, 100% interruptions 250 periods, perf. Criteria B				
MTBF	as per MIL-HDBK-217F at 25°C	300,000			hours
RoHS	yes				

ENVIRONMENTAL

parameter	conditions/description	min	typ	max	units
operating temperature	see derating curves	-40		85	°C
storage temperature		-40		85	°C
operating humidity	non-condensing			90	%
altitude				5,000	m

DERATING CURVES

TEMPERATURE DERATING CURVE
(at 80~264 Vac / 100~370 Vdc)

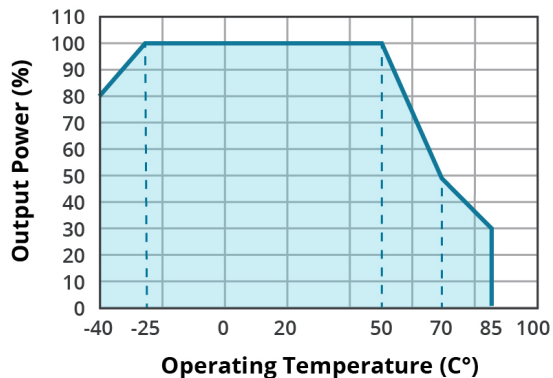

INPUT VOLTAGE DERATING CURVE
(at 25°C)

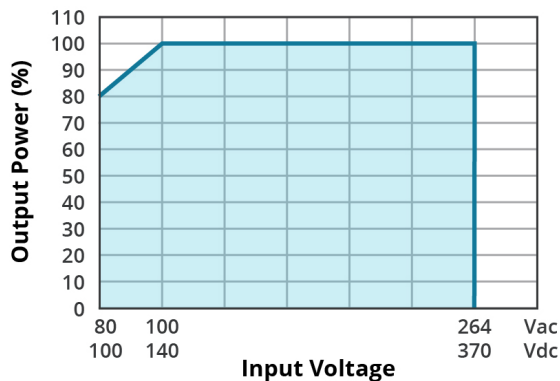

ALTITUDE DERATING CURVE

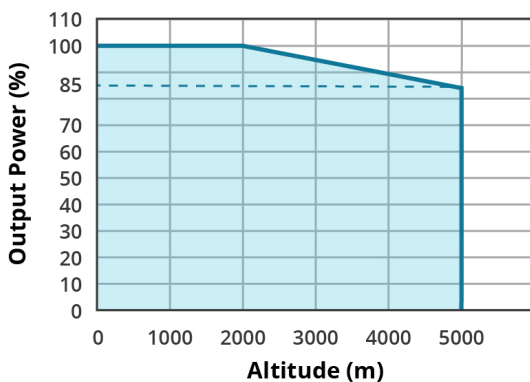

Note: With an AC input between 80-100VAC and a DC input between 100-140VDC, the output power must be derated as per temperature derating curves.

EFFICIENCY CURVES

EFFICIENCY VS INPUT VOLTAGE
(full load)

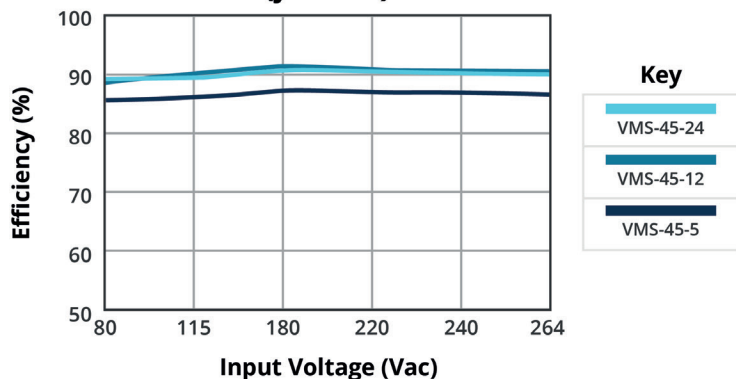

EFFICIENCY VS OUTPUT LOAD
(Vin = 230 Vac)

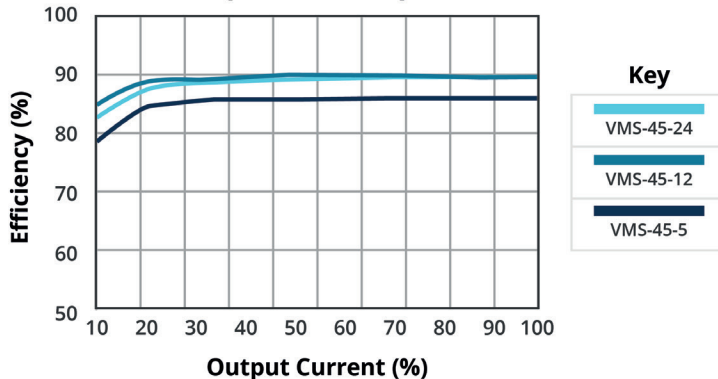

MECHANICAL

parameter	conditions/description	min	typ	max	units
dimensions	open frame models: 76.20 x 50.80 x 26.50 [3.0 x 2.0 x 1.043 inch] covered models: 91.40 x 60.50 x 33.30 [3.598 x 2.382 x 1.311 inch]				mm mm
weight	open frame models covered models		95 150		g g
cooling	natural convection (no integrated fan)				

MECHANICAL DRAWING

Open-frame

units: mm [inch]

general tolerance: ±0.50 [±0.020]

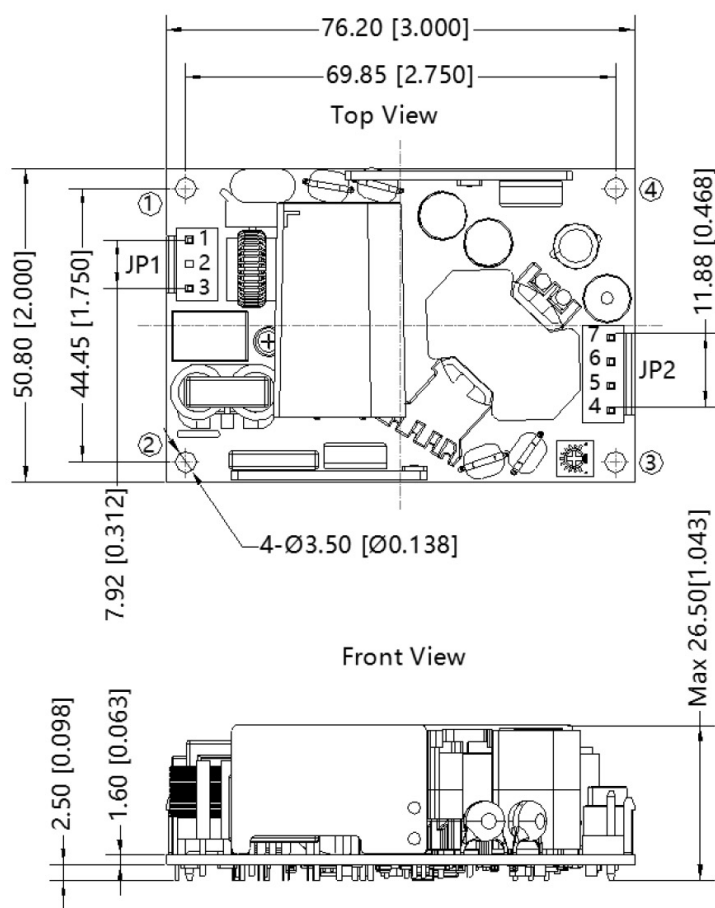

PIN-OUT			
Connectors	PIN	Function	Client Connector
JP1	1	AC (L)	Housing: JST VHR Contact: JST SVH-21T-P1.1 or equivalent
	2	NC	
	3	AC (N)	
JP2	4	-Vo	Housing: JST VHR Contact: JST SVH-21T-P1.1 or equivalent
	5	-Vo	
	6	+Vo	
	7	+Vo	

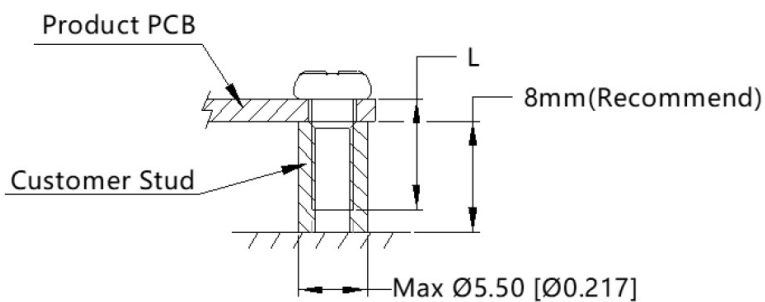

MOUNTING SCREWS			
Position	Screw Spec.	L (recommended)	Torque
①~④	M3	6mm	0.4 N·m

MECHANICAL DRAWING (CONTINUED)

Covered

units: mm [inch]

general tolerance: ±0.50 [±0.020]

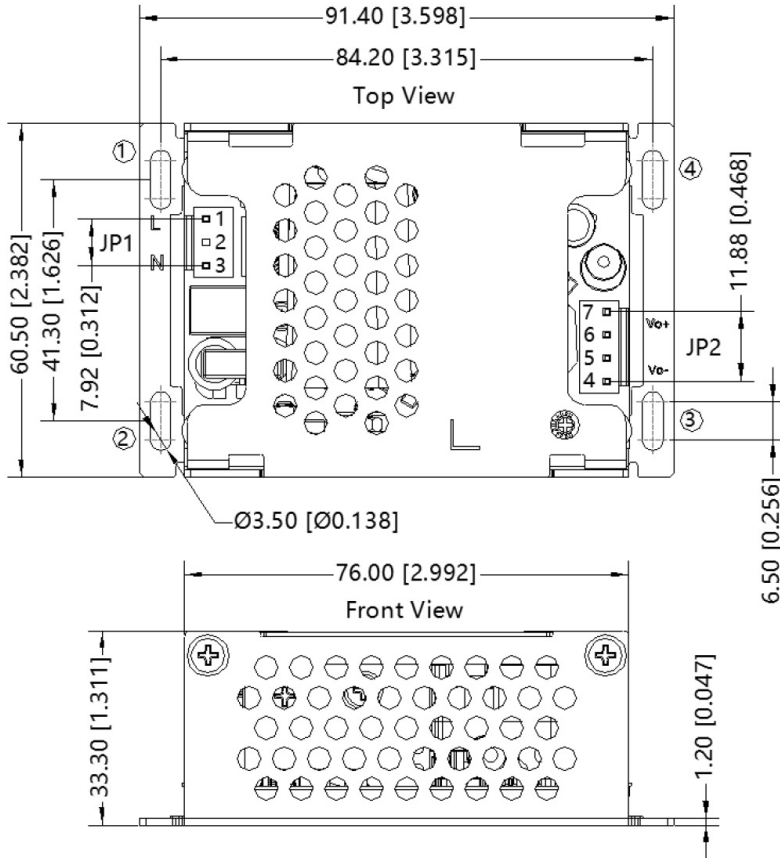

PIN-OUT			
Connectors	PIN	Function	Client Connector
JP1	1	AC (L)	Housing: JST VHR Contact: JST SVH-21T-P1.1 or equivalent
	2	NC	
	3	AC (N)	
JP2	4	-Vo	Housing: JST VHR Contact: JST SVH-21T-P1.1 or equivalent
	5	-Vo	
	6	+Vo	
	7	+Vo	

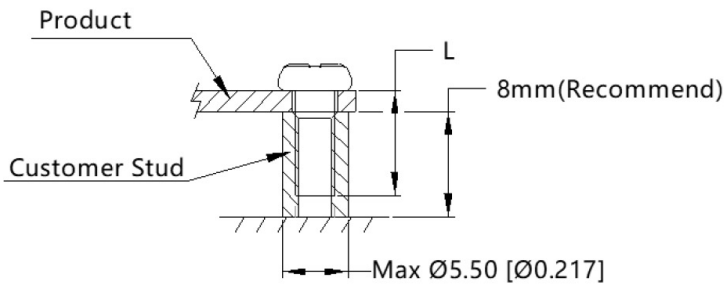

MOUNTING SCREWS			
Position	Screw Spec.	L (recommended)	Torque
①~④	M3	6mm	0.4 N·m

REVISION HISTORY

rev.	description	date
1.0	initial release	10/06/2022
1.01	derating curves updated	03/30/2023
1.02	medical icon added	05/04/2023

The revision history provided is for informational purposes only and is believed to be accurate.



CUI INC

a bel group

Headquarters
20050 SW 112th Ave.
Tualatin, OR 97062
800.275.4899

Fax 503.612.2383
cui.com
techsupport@cui.com

CUI offers a two (2) year limited warranty. Complete warranty information is listed on our website.

CUI reserves the right to make changes to the product at any time without notice. Information provided by CUI is believed to be accurate and reliable. However, no responsibility is assumed by CUI for its use, nor for any infringements of patents or other rights of third parties which may result from its use.

CUI products are not authorized or warranted for use as critical components in equipment that requires an extremely high level of reliability. A critical component is any component of a life support device or system whose failure to perform can be reasonably expected to cause the failure of the life support device or system, or to affect its safety or effectiveness.